

61, rue Jean Jaurès - 91160 CHAMPLAN  
 Tél : 33(0)1 69 74 10 90 – Fax : 33(0)1 69 74 10 99  
<http://www.hitec.fr> - e-mail : info@hitec.fr

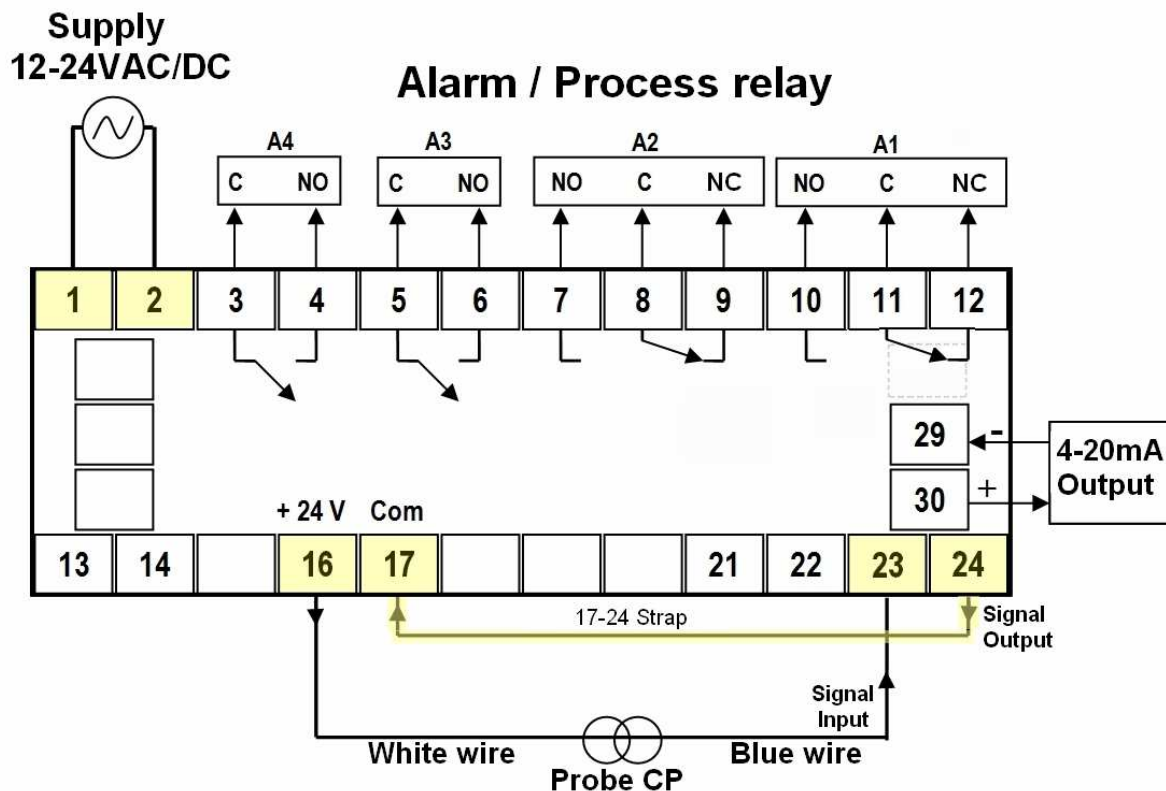

## Simplified user manual ALP942-24

### 1. Standard electrical connection with a 4-20mA probe



### 2. Basic standard configuration

The ALP942-24 display is supplied as standard with a configuration **for a 4-20mA signal input** (type of level sensor or pressure) set for a standard display 0-100% of the scale proportional to the measurement signal.

The signal copy will also be set for a 4-20mA for 100% of the scale.



The 4 relays will be configured as follows:

- A1: Very low level TB 10% of full scale (PE) Hysteresis 1%
- A2: Low level B 20% of full scale (PE) Hysteresis 1%
- A3: High level H 80% of full scale (PE) Hysteresis 1%
- A4: Very high level TH 90% of full scale (PE) Hysteresis 1%



### 3. Basic setting for a height display

Start with full scale 4-20mA signal.

For example to display a height of 6.00 meters for 20mA (instead of 100% initial):

Hold down  and press the key 3 times  until the **In.tYP** is displayed

Then press 5 times  until you get the **In.H IL** display which will alternate with the value of **100.00** ( (100%)

Then modify with the buttons  or  the display to obtain the desired value (for example **6.00** ( (for 6.00m)

Then press  to find the display value



N.B .: Note that you can always go back in the program by pressing the Back key :



### 4. Parameters for cylinder tank volume display



For example to display a volume of 3000 liters for 20mA (instead of 100% initial), integrating the shape of the tank and the charts of it:





Start by changing the signal input:

Hold down  and press the key  3 times until you get the display: **In.tYP** and **4-20A**

Change the input by pressing 2 times  to get **c.4-20**

Then press  once to display **dPPoS** and move the point decimal with the arrows  and  (For 3000, the point must disappear).

Then press simultaneously on  and  to get the first **InP.0 I** signal input value that displays **4.000**

Then press  to get **InP.02** and enter the 2nd value of signal with the  and  then press  until the 30th value **InP.30** which will be in general **20.000** (for 20.000 mA) and then by pressing  you will have the first volume to enter **out.0 I** which will usually be **0000** then enter the same way

the following values until **out.30** which will be **3000** for 3000 liters) and finish by pressing one last times  on to exit the program.

Note that you can always go back to the input values by pressing the Return key



Note also that about ten input values are sufficient for the accuracy of the volume of a cylindrical tank. In this case, since the 10th value you pass the following by pressing

## 5. Settings of process / alarms

From the signal display, you can view the alarm values by pressing

**SPAL 1 : 10.00** (in std) then again on  **SPAL 2 : 20.00** and

**SPAL 3 : 80.00** and  **SPAL 4 : 90.00**

You can change these values by pressing  or

As standard, alarms A1 and A2 are set to low alarm (**FuAL** in **Lo**) and hysteresis (**HYAL** to min 1.00, and ready for a drain process while alarms A3 and A4 are set to high alarm ((**FuAL** in **H**) and hysteresis (**HYAL**) at 1.00 min and ready for filling process.

Access the program for setting the types of alarms starting from the signal by pressing once  and  to get **FuAL 1** and **Lo**

Pass from **SPAL 1** to **SPAL 2** then **SPAL 3** and **FuAL 1** and **HYAL 1** by pressing the key  
Summary table of the alarm pre-settings.

Relays		A	SPAL	FuAL	HYAL	OFF	ON
Very low	TB	1	10.00	Lo	1.00	>11.00	<10.00
Low	B	2	20.00	Lo	1.00	>21.00	<20.00
High	H	3	80.00	Hi	1.00	<79.00	>80.00
Very high	TH	4	90.00	Hi	1.00	<89.00	>90.00

Then pass the functions **SbLAL** and **AL It...** all to **0** by pressing the key  until you exit the program and return to the signal display value.

Work	Alarm	Fonct.	Setting	Linea	Span
----	FuRAL 1 to 4	FFunc OFF	intYP 4-20R or c4-20	inPD 1 inP.30	inLoC
ALREF	dFAL 1 to 4	dG.in OFF	dPPoS 0.00	out.D 1 out.30	inH IC
SPAL 1 à SPAL 4	MYAL 1 to 4	FILtr 0 to 60	Unit		ouLoC
	BLAL 1 to 4	oFSEt 0	Sroot no		ouH IC
	AL.it 1 to 4	bAud	ScALE 0		CLLo
	AL.it 2 to 4	AdRES	inLoL 0		HTYPE
			inH L Full scale		
			Out.tY 4- 20R		
			OutLoL 0		
			ouH L Full scale		
			outEr do		